

DESPIECE TÉCNICO
SPARE PARTS LIST

ARMARIOS SNACK / SNACK CABINETS

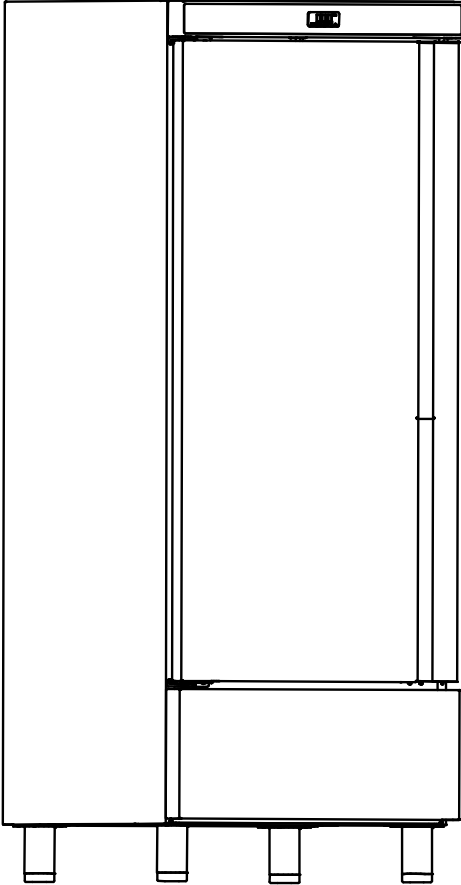

MODELOS

MODELS

ARMARIO 1C POSIT.
ARMARIO 1C CONG.

OPCIONES

OPTIONALS

Abr.	Descripción	Description
C	Ruedas	Castor
GD	Puerta de Cristal	Glass Door
OP	Apertura contraria	Opposite door opening
CI	Clavija inglesa	English plug

* En caso de tener una versión con opciones, revisar también la página de las opciones

* In case you purchased model with an optional, also review the page with optionals details

Vers. Apryl 2024
Revised



DESPIECE TÉCNICO
SPARE PARTS LIST

	DESCRIPCIÓN / DESCRIPTION / DESCRIPTION	PAG.
A	MUEBLE / UNIT	1
-	LISTA MATERIALES	2
-	VARIACIONES OPCIONALES / OPTINAL VARIATION	3
ANEXO_1	CUSTOMIZABLE / PERSONALIZABLE	4
ANEXO_2	CUSTOMIZABLE / PERSONALIZABLE	5
B	ESQUEMA ELÉCTRICO / ELECTRIC SCHEM ARMARIO 1C POSITIVO	6
C	ESQUEMA ELÉCTRICO / ELECTRIC SCHEM ARMARIO 1C CONGELACIÓN	7

Los dibujos representados en este documento son orientativos y pueden no reproducir con exactitud las piezas en cuestión. Los aparatos están sujetos a modificaciones sin previo aviso. Asegúrese de consultar la última versión del despiece técnico y de pedir las piezas compatibles con su modelo según la fecha de fabricación.

The drawings shown in this document are for guidance and might not represent the parts accurately. The machinery is subject to change without prior notice. Please, ensure that this is the most recent revision of the spare parts manual, and that you are ordering suitable parts for your model considering its date of manufacture.

ARMARIO 1 CUERPO / SINGLE BODY CABINETS

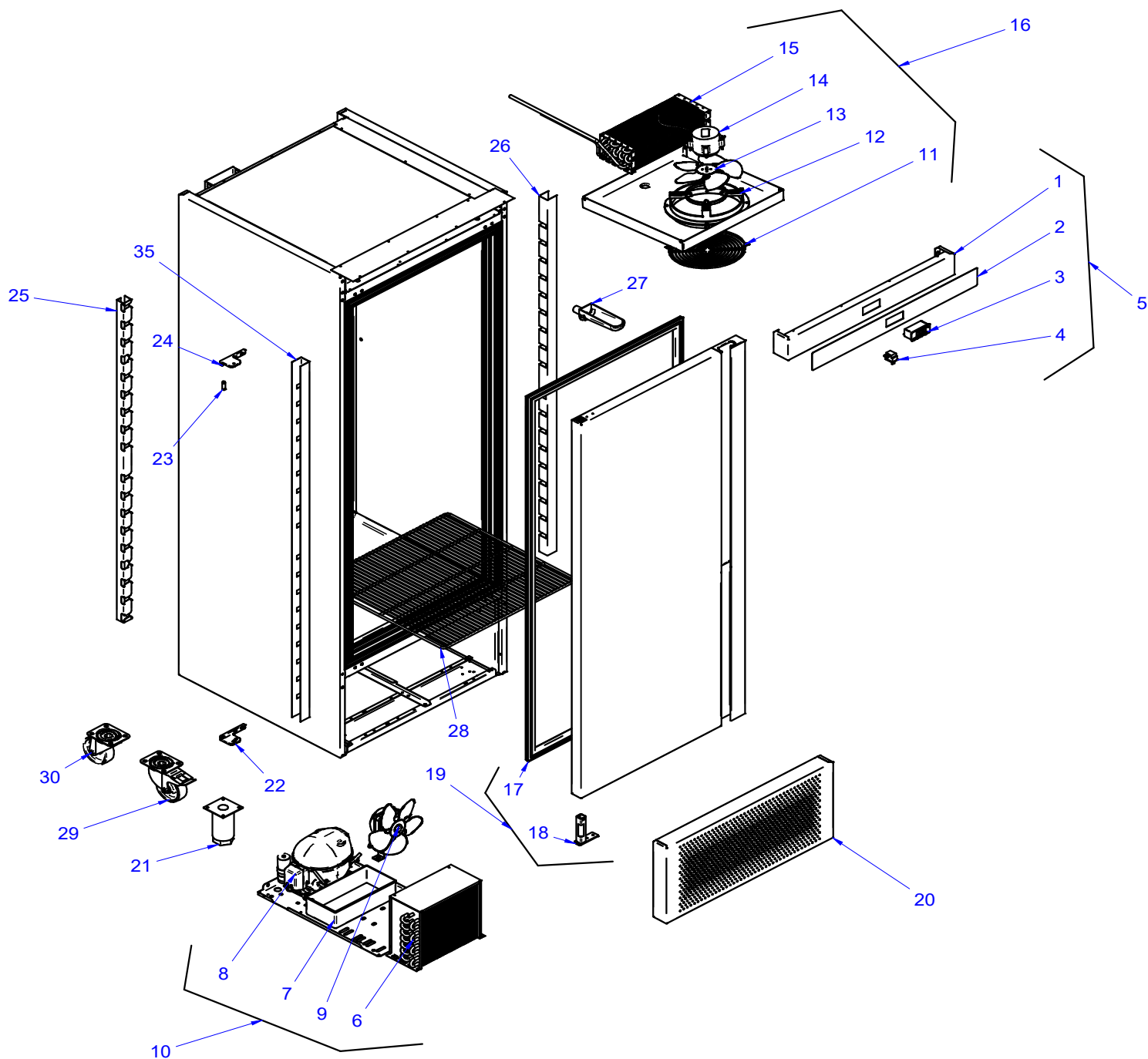

ESTRUCTURA ARMARIO 1 CUERPO
STRUCTURE SINGLE BODY CABINETS

ITEM	REFERENCIA REFERENCE	DENOMINACIÓN	DENOMINATION	ARM. 1C 1PUERTA POSIT	ARM. 1C 2PUERTAS POSIT	ARM. 1C 1PUERTA CONG.	ARM. 1C 2PUERTAS CONG	RECOMENDADO RECOMMENDED	ELIMINADO ELIMINATED	INTRODUCIDO INTRODUCED	NOTAS NOTES
3	ANEXO	TERMOSTATO	THERMOSTAT	1	1			X			
3	ANEXO	TERMOSTATO	THERMOSTAT			1	1	X			
4	12036888	MICROR.CONMUT.E3111CA GRIS	MICROR.CONMUT.E3111CA GRIS	1	1						
4	12101812	MICRO. CONMUT. HH3141CA BLANCO	MICRO. CONMUT. HH3141CA BLANCO			1	1				
6	12032377	CONDENSADOR	CONDENSER	1	1						
6	12061043	CONDENSADOR	CONDENSER			1	1				
7	12036623	BANDEJA EVAPORACION AUTOMÁTICA	AUTOMATIC ESTEAMATION TRAY	1	1	1	1				
8	12253332	COMPRESOR	COMPRESSOR			1	1	X			
8	12138143	COMPRESOR	COMPRESSOR	1	1			X	Oct. 2023		
8	12292989	COMPRESOR	COMPRESSOR	1	1					Oct. 2023	
9	12059041	VENTILADOR	FAN	1	1	1	1	X			
10	12165726	UNIDAD CONDENSADORA	COND. UNIT.	1	1				Oct. 2023		
10	12295439	UNIDAD CONDENSADORA	COND. UNIT.	1	1					Oct. 2023	
10	12136771	UNIDAD CONDENSADORA	COND. UNIT.				1	1			
11	12034663	REJILLA VENTILADOR	FAN GRID	1	1	1	1				
12	12131156	BAFLE VENTILADOR EVAPORADOR	FAN-EVAPORATOR BAFLE	1	1	1	1				
13	12087196	ASPA VENTILADOR ALUMINIO	ALUMINIUM FAN BLADE	1	1	1	1				
14	12132522	VENTILADOR	FAN	1	1						
14	12135265	VENTILADOR	FAN				1	1	X		
15	12068174	EVAPORADOR	EVAPORATOR	1	1	1	1				
16	12222176	UNIDAD EVAPORADORA	EVAP. UNIT.	1	1						
16	12136768	UNIDAD EVAPORADORA	EVAP. UNIT.				1	1			
17	12320053	BURLETE PUERTA PEQUEÑA	GASKET DOOR		2		2				
17	12320054	BURLETE PUERTA CARNICERA	GASKET DOOR	1		1					
18	12038130	BISAGRA DOBLE MUELLE	SPRING DOUBLE HINGE	1	2	1	2				
19	ANEXO	PUERTA CARN AP IZD	LEFT DOOR	1		1					
19	ANEXO	PUERTA PEQ AP IZD	LITTLE LEFT DOOR		2		2				
21	12033566	PATA REGULAB ARM GASTRO	PATA REGULAB ARM GASTRO	4	4	4	4				
22	12036986	SOPORTE BISAGRA INFER. IZDA. GAMA ADV.	LEFT LOW HINGE SUPPORT	1	2	1	2				
23	12038076	EJE 30x10 VARILLA INOX. ROSCA INTER. M6	SUP HUB. 30x10 ROD DOORS INOX.INT. M-6	1	1	1	1				
24	12041474	SOPT.BISAGRA SUPERIOR IZQUIERD	LEFT TOP HINGE SUPPORT	1	1	1	1				
25	12034579	CREMALL.INT.	CREMALL.INT.	2	2	2	2				
26	12034241	CREMALL.DEL.DCH.	CREMALL.DEL.DCH.	1		1					
26	12035502	CREM.DELANT.DCH.PEQ.	CREM.DELANT.DCH.PEQ.		2		2				
27	12037314	CANALIZ AGUA 150 NEGRO CONG	CONG 150 BLACK WATER PIPE			1	1				
27	12037375	CANALIZ AGUA 150 GRIS REFRIG	REF 150 GREY WATER SHROUD	1	1						
28	12034317	PARRILLA	GRILL	3	3	3	3				
35	12034240	CREMAL.DEL.IZD.	CREMAL.DEL.IZD.	1		1					
35	12035504	CREM.DELANT.IZD.PEQ.	CREM.DELANT.IZD.PEQ.		2		2				
8*	12058824	COND ARRANQ FR 117U5015 80MF D	COND ARRANQ FR 117U5015 80MF D			1	1	X			
8*	12058872	RELE ARRAN NL-7-CN 117U7002	RELE ARRAN NL-7-CN 117U7002			1	1	X			
8*	12140199	RELE ARRANQ	RELE ARRANQ	1	1				Oct. 2023		
8*	12058820	COND ARRANQ	COND ARRANQ	1	1				Oct. 2023		
*	12036014	RESIST.MARCO EXT.700/800 20W	FRAME RESISTANCE			1	1				
*	12036313	RESIST.BANDEJA 700- 16,5W	TRAY RESISTANCE			1	1				
*	12036316	RESIST.FRONTI H.1400-1600 5,5W	HORIZONTAL FRAME RESISTANCE				1				
*	12253561	RESIST.BLIND. EVAP. 5x4.7x4 HC 350W 230V	EVAP. RESISTANCE			1	1				
*	12036805	MANG 3X1X2500 BL. SCHUKO 3T TERMINALES	HOSE.3X1X2500mmWHITE CLA.SH	1	1	1	1				
*	12257133	INTERCAMBIADOR	CAPILLARY SET	1	1	1	1				
*	12036776	SOPORTE BISAGRA CENTRAL	CENTRAL SUPPORT			1	1				

VARIACIONES OPCIONALES / OPTINAL VARIATION

Abrev.	Descripción / Description	ITEM	Reference	Descripción	Description	ARM. 1C 1PUERTA POSIT	ARM. 1C 2PUERTAS POSIT	ARM. 1C 1PUERTA CONG.	ARM. 1C 2PUERTAS CONG.	RECOMENDADO RECOMMENDED	ELIMINADO ELIMINATED	INTRODUCIDO INTRODUCED	NOTAS NOTES
C	RUEDAS / CASTOR	30	12032673	RUEDA S/F D100 ARM.	D100 GIRAT.SIN WHEEL BRAKE ARM	2	2	2	2				
		29	12033761	RUEDA C/FRENO D100 ARMARIO	ROTATING.C WHEEL / BRAKE ASSEMBLY D100	2	2	2	2				
		*	12117149	LED	LED	1							
GD	PUERTA CRISTAL / GLASS DOOR	*	12321524	FUENTE ALIMENTACIÓN	POWER SUPPLY	1							
		19	12215424	PUERTA CRISTAL IZQ	LEFT GLASS DOOR	1							
		19	12210609	PUERTA CRISTAL DCH	RIGHT GLASS DOOR	1							
		19	ANEXO	PUERTA AP. DCHA	AP. RIGHT DOOR	1		1					
		19	ANEXO	PUERTA PEQ AP. DERECHA	LITTLE AP. RIGHT DOOR		2		2				
OP	APERTURA CONTRARIA DE PUERTA / OPPOSITE DOOR	24	12041472	SOPT.BISAGRA SUPERIOR DERECHO	UPPER RIGHT SUPPORT HINGE	1	1	1	1				
		22	12037017	SOPORTE BISAGRA INFER. DCHA. GAMA ADV.	LOW. HINGE SUPPORT RIGHT RANGE ADV.	1	1	1	1				
		*	12037088	SOPORTE BISAGRA CENTRAL	CENTRAL SUPPORT		1		1				
CI	CLAVIJA INGLESA / ENGLISH PLUG	*	12067656	MANGUERA CON CLAVIJA INGLESA 3X1.5	HOSE 3X1.5X2500 ENG PLUG	1	1	1	1				
FH	RESISTENCIA MARCO PUERTA / FRAME HEATER	*	12036014	RESIST.MARCO EXT.700/800 20W	FRAME RESISTANCE	1	1						
		*	12036316	RESIST.FRONTI H.1400-1600 5,5W	HORIZONTAL FRAME RESISTANCE		1		1				

POSIBLES OPCIONES PARA LAS DISTINTAS POSICIONES

ITEM_19

12122202 PUERTA CARNIERA AP. DCH
12122183 PUERTA CARNICERA AP. IZQ

12122291 PUERTA PEQ. AP DCH
12122290 PUERTA PEQ. AP IZQ

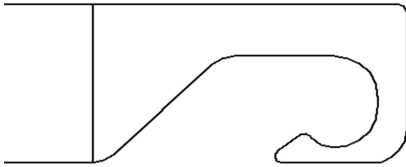

12079559 PUERTA CARNIERA AP. DCH
12079558 PUERTA CARNICERA AP. IZQ

12079557 PUERTA PEQ. AP DCH
12044925 PUERTA PEQ. AP IZQ

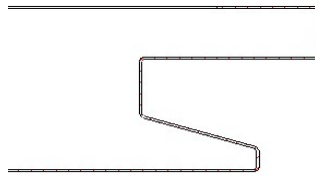

12083611 PUERTA CARNIERA AP. DCH
12083609 PUERTA CARNICERA AP. IZQ

12083612 PUERTA PEQ. AP DCH
12083610 PUERTA PEQ. AP IZQ

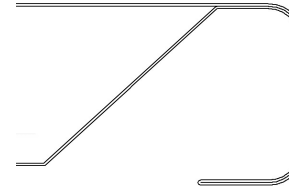

ITEM 3 (OPCIONES)

12047691 TERMOSTATO REFRIGERACIÓN
12049777 TERMOSTATO CONGELACIÓN



12213060 TERMOSTATO REFRIGERACIÓN
12213064 TERMOSTATO CONGELACIÓN



INTERRUPTOR BIPOLAR (OPCIONES)

12037293 INT. BIPOLAR_LUMINOSO AMBAR

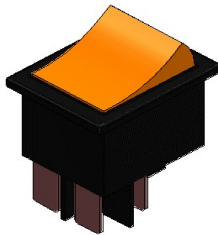

12049461 INT. BIPOLAR NEGRO

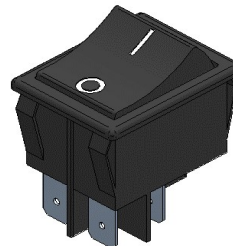

INTERRUPTOR UNIPOLAR (OPCIONES)

12037353 INT. UNIPOLAR_LUMINOSO AMBAR

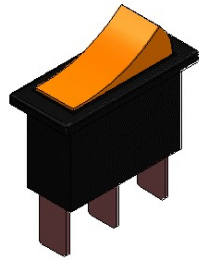

12058759 INT. UNIPOLAR NEGRO

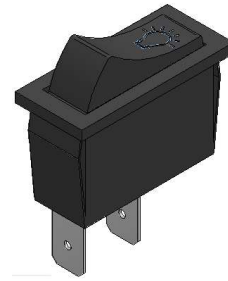

TIRADOR PUERTA DE CRISTAL

12068289 TIRADOR_1

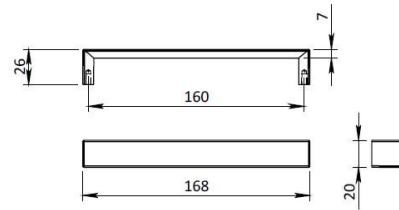
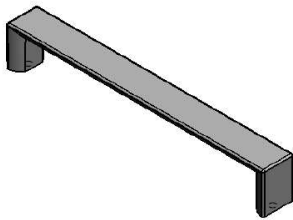

12068291 TIRADOR_2

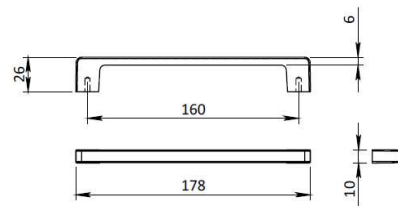
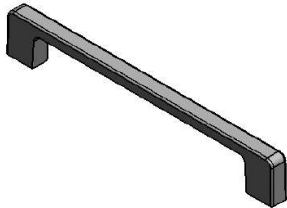

12068290 TIRADOR_3

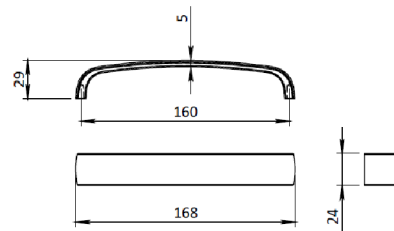
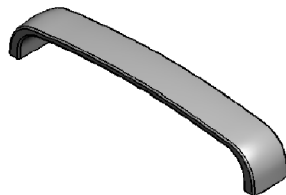

ARMARIO 1C POSITIVO

ESQUEMA ELÉCTRICO - ELECTRICAL SCHEMATIC

Armarios Refrigerados

Refrigerated Cabinet

Simbología - Symbols

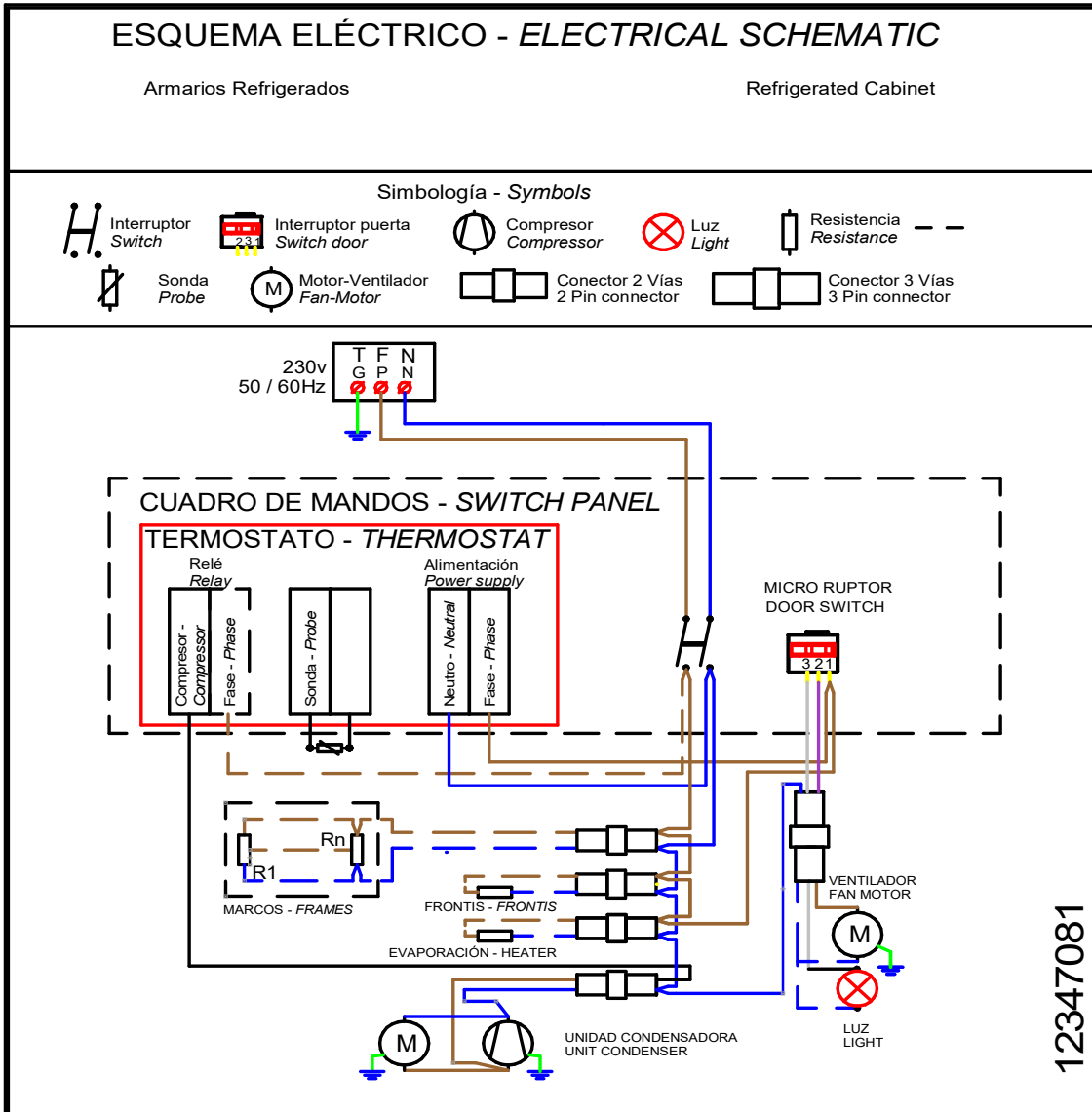
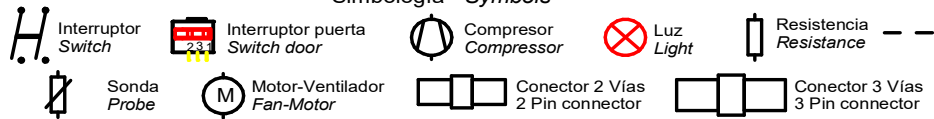

12347081

ARMARIO 1C CONGELACIÓN

