

DESPIECE TÉCNICO  
SPARE PARTS LIST

MESAS SNACK / SNACK COUNTERS

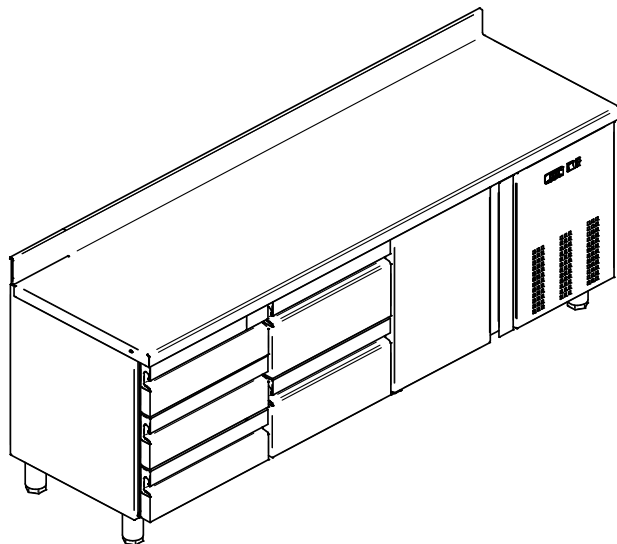

**MODELOS**

**MODELS**

MESA SNACK 2P POSIT.  
MESA SNACK 3P POSIT.  
MESA SNACK 4P POSIT.

MESA SNACK 2P CONG.  
MESA SNACK 3P CONG.

**OPCIONES**

**OPTIONALS**

<b>Abr.</b>	<b>Descripción</b>	<b>Description</b>
<b>C</b>	Ruedas	Castor
<b>GD</b>	Puerta de Cristal	Glass Door
<b>OP</b>	Apertura contraria	Opposite door opening
<b>CI</b>	Clavija inglesa	English plug
<b>AU</b>	Clavija australiana	Australian plug
<b>AM</b>	Clavija americana	USA plug
<b>FH</b>	Resistencia marco puerta	Frame heater
<b>NT</b>	Sin encimera	Without top
<b>LG</b>	Grupo izquierda	Left group
<b>NS</b>	Sin peto	Without splash-back

\* En caso de tener una versión con opciones, revisar también la página de las opciones

**Vers.** APRIL 2024  
**Revised**

\* In case you purchased model with an optional, also review the page with optionals details

# DESPIECE TÉCNICO SPARE PARTS LIST

---

	DESCRIPCIÓN / DESCRIPTION / DESCRIPTION	PAG.
A	MUEBLE / UNIT	1
-	LISTA MATERIALES	2
-	LISTA MATERIALES	3
Optionals_1	VARIACIONES OPCIONALES / OPTINAL VARIATION	4
Optionals_2	VARIACIONES OPCIONALES / OPTINAL VARIATION	5
ANEXO_1	CUSTOMIZABLE / PERSONALIZABLE	6
ANEXO_2	CUSTOMIZABLE / PERSONALIZABLE	7
B	ESQUEMA ELÉCTRICO/ELECTRIC SCHEME MESA SNACK POSITIVA	8
C	ESQUEMA ELÉCTRICO/ELECTRIC SCHEME MESA SNACK NEGATIVA	9

---

Los dibujos representados en este documento son orientativos y pueden no reproducir con exactitud las piezas en cuestión. Los aparatos están sujetos a modificaciones sin previo aviso. Asegúrese de consultar la última versión del despiece técnico y de pedir las piezas compatibles con su modelo según la fecha de fabricación.

The drawings shown in this document are for guidance and might not represent the parts accurately. The machinery is subject to change without prior notice. Please, ensure that this is the most recent revision of the spare parts manual, and that you are ordering suitable parts for your model considering its date of manufacture.

# MESAS SNACK / SNACK COUNTERS

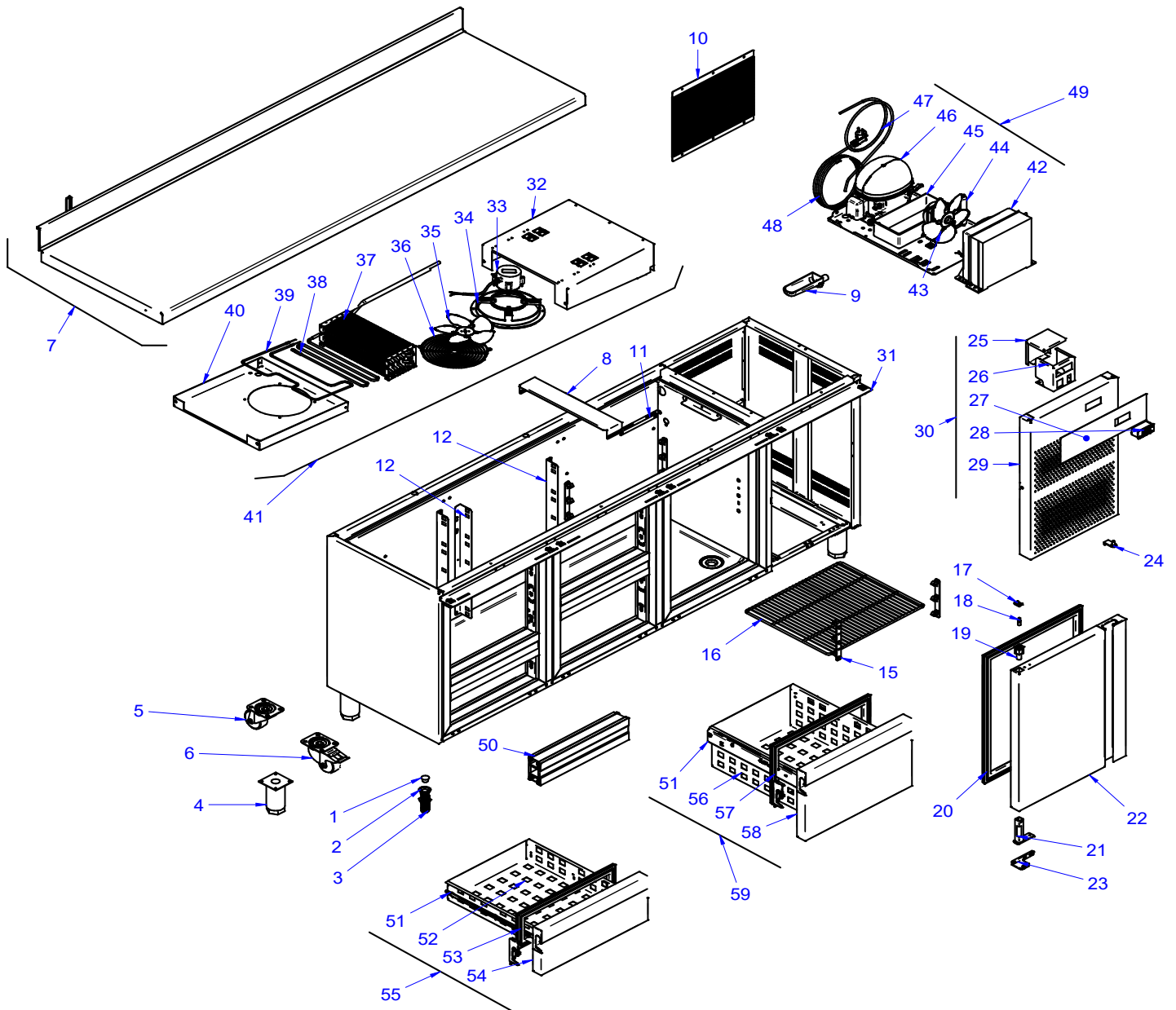

ITEM	REFERENCIA REFERENCE	DENOMINACIÓN	DENOMINATION	MESA 2P POSIT	MESA 3P POSIT	MESA 4P POSIT	MESA 2P POSIT HD	MESA 2P POSIT HH	MESA 3P POSIT HDD	MESA 3P POSIT HHD	MESA 3P POSIT HHH	MESA 4P POSIT HDDD	MESA 4P POSIT HHDD	MESA 4P POSIT HHHH	MESA 2P CONG	MESA 3P CONG	RECOMENDADO RECOMMENDED	ELIMINADO ELIMINATED	INTRODUCIDO INTRODUCED	NOTAS NOTES
1	12037989	TAPON DESAGÜE	DRAIN PLUG	1	1	1	1	1	1	1	1	1	1	1	1	1				
2	12037891	JUNTA GOMA DESAGÜE	DRAIN GASKET	1	1	1	1	1	1	1	1	1	1	1	1	1				
3	12037489	DESAG COMPL 3/4 GRIS+TUERCA	DRAIN	1	1	1	1	1	1	1	1	1	1	1	1	1				
4	12033566	PATA REGULABLE	ADJUSTABLE LEG	4	4	6	4	4	4	4	4	6	6	6	6	4	4			
7	ANEXO	ENCIMERA 4P	WORKTOP 4P				1					1	1	1	1					
7	ANEXO	ENCIMERA 3P	WORKTOP 3P		1				1	1	1								1	
7	ANEXO	ENCIMERA 2P	WORKTOP 2P	1			1	1									1			
8	12036764	FIJACIÓN UNIDAD EVAPORADORA	EVAPORATOR UNIT FIXING	1	1	1	1	1	1	1	1	1	1	1	1	1	1			
9	12037314	CANALIZADOR AGUA	WATER CHANNEL													1	1		X	
9	12037375	CANALIZADOR AGUA	WATER CHANNEL	1	1	1	1	1	1	1	1	1	1	1	1					X
10	12036793	REJ.RESP.GRUPO	GROUP BACK GRILLE	1	1	1	1	1	1	1	1	1	1	1	1	1				
11	12073795	PROTECTOR SONDA	PROBE PROTECTOR	1	1	1	1	1	1	1	1	1	1	1	1	1				
12	12038107	CREMLL.RESPALDO	BACK ZIPPER				2	2	2	4	4	2	4	6	6					
12*	12038097	CREMLL.RESPALDO L.G.	BACK ZIPPER L.G.				2				2				2					
15	12037728	SOPORTE PARRILLA	GRILL SUPPORT	8	12	16	4		8	4		12	8	4		8	12			
16	12034975	PARRILLA	GRILL	2	2	2	1		1	1		1	1	1		2	2			
16	12034847	PARRILLA CENTRO	CENTER GRILL		1	2			1			2	1				1			
17	12050272	TUERCA TRT M6-2	NUT TRT M6-2	3	4	5	2	1	3	2	1	4	3	2	1	3	4			
18	12037138	EJE ROSCA EXT.30x10 INOX	SHAFT EXTERNAL THREAD	3	4	5	2	1	3	2	1	4	3	2	1	3	4			
19	12037723	CAJA ALOJAMIENTO	HOUSING BOX	2	3	4	1		2	1		3	2	1		2	3			
20	12035412	BURLETE	GASKET	2	3	4	1		2	1		3	2	1		2	3		X	
21	12038130	BISAGRA DOBLE MUELLE	DOUBLE SPRING HINGE	2	3	4	1		2	1		3	2	1		2	3		X	
22	ANEXO	PUERTA	DOOR	2	3	4	1		2	1		3	2	1		2	3		X	
23	12036986	SOPORTE BISAGRA INFER. IZDA.	HINGE SUPPORT INF. LEFT	2	3	4	1		2	1		3	2	1		2	3		X	
24	12037372	SOPORTE ZAMAK REJILLA	ZAMAK GRID SUPPORT	1	1	1	1	1	1	1	1	1	1	1	1	1	1			X
25	12150384	PROTECCION PJ	PJ PROTECTION	1	1	1	1	1	1	1	1	1	1	1	1	1				
26	12150386	SOPORTE PJ	PJ SUPPORT	1	1	1	1	1	1	1	1	1	1	1	1	1				
28	ANEXO	TERMOSTATO	THERMOSTAT	1	1	1	1	1	1	1	1	1	1	1	1					X
28	ANEXO	TERMOSTATO	THERMOSTAT													1	1			X
28*	12045530	SONDA TERMOSTATO	THERMOSTAT PROBE	1	1	1	1	1	1	1	1	1	1	1	1	2	2			

ITEM	REFERENCIA	DENOMINACIÓN	DENOMINATION	MESA 2P POSIT	MESA 3P POSIT	MESA 4P POSIT	MESA 2P POSIT HD	MESA 2P POSIT HH	MESA 3P POSIT HDD	MESA 3P POSIT HHD	MESA 3P POSIT HHH	MESA 4P POSIT HDDD	MESA 4P POSIT HDDD	MESA 4P POSIT HHHH	MESA 2P CONG	MESA 3P CONG	RECOMENDADO RECOMMENDED	ELIMINADO ELIMINATED	INTRODUCIDO INTRODUCED	NOTAS NOTES
31	12033254	SOP.SUP.PUERTAS 3P	UPPER SUPPORT DOORS 3P		1				1	1	1					1				
31	12033966	SOP.SUP.PUERTAS 2P	UPPER SUPPORT DOORS 2P	1			1	1							1					
31	12035853	SOP.SUP.PUERTAS 4P	UPPER SUPPORT DOORS 4P			1						1	1	1	1					
32	12238937	TECHO EVAPORADOR	EVAPORATOR ROOF	1	1	1	1	1	1	1	1	1	1	1	1	1				
33	12132522	VENTILADOR 5W	FAN 5W	1	1	1	1	1	1	1	1	1	1	1						X
33	12326874	VENTILADOR 7W	FAN 7W												1	1				X
34	12131156	BAFLE VENTILADOR EVAPORADOR	FAN BAFFLE	1	1	1	1	1	1	1	1	1	1	1	1	1				
35	12087196	ASPA VENTILADOR	FAN BLADE	1	1	1	1	1	1	1	1	1	1	1	1	1				
36	12034663	REJILLA VENTILADOR	FAN GRIDE	1	1	1	1	1	1	1	1	1	1	1	1	1				
37	12068174	EVAPORADOR	EVAPORATOR	1	1	1	1	1	1	1	1	1	1	1						X
37	12068174	EVAPORADOR	EVAPORATOR												1	1				X
38	12351308	RESIST.BLIND. EVAP.	RESISTOR EVAPORATOR												1	1				X
39	12036313	RESIST.BANDEJA	RESISTOR												1	1				X
40	12238398	TAPA EVAPORADOR	EVAPORATOR COVER	1	1	1	1	1	1	1	1	1	1	1	1	1				
41	12239089	UNIDAD EVAPORADORA	EVAPORATOR UNIT	1	1	1	1	1	1	1	1	1	1	1						
41	12239084	UNIDAD EVAPORADORA	EVAPORATOR UNIT												1	1				
42	12032377	CONDENSADOR	CONDENSER	1	1	1	1	1	1	1	1	1	1	1						X
42	12050285	CONDENSADOR	CONDENSER												1	1				X
43	12059041	VENTILADOR 5W	FAN 5W	1	1	1	1	1	1	1	1	1	1	1						X
43	12326874	VENTILADOR 7W	FAN 7W																	
44	12061055	FILT DESHID 20GR	FILTRE 20 GR	1	1	1	1	1	1	1	1	1	1	1	1	1				
45	12036623	BANDEJA EVAPORACION AUTOMÁTICA	EVAPORATION TRAY	1	1	1	1	1	1	1	1	1	1	1	1	1				
46	12253307	COMPRESOR	COMPRESSOR	1	1		1	1	1	1										X Nov.2023
46	12292989	COMPRESOR	COMPRESSOR	1	1		1	1	1	1										X Nov.2023
46	12253308	COMPRESOR	COMPRESSOR			1					1	1	1	1						X
46	12253332	COMPRESOR	COMPRESSOR												1	1				X
47	12037532	CAPILAR	CAPILLARY	1	1		1	1	1	1	1									X
47	12035701	CAPILAR	CAPILLARY			1						1	1	1	1					X
47	12136355	CAPILAR	CAPILLARY																	
48	12036805	MANG CON CLAVIJA SCHUKO	MANG CON CLAVIJA SCHUKO	1	1	1	1	1	1	1	1	1	1	1	1	1				
49	12129711	UNIDAD CONDENSADORA	CONDENSING UNIT	1	1		1	1	1	1										Nov.2023
49	12295450	UNIDAD CONDENSADORA	CONDENSING UNIT	1	1		1	1	1	1										Nov.2023
49	12129712	UNIDAD CONDENSADORA	CONDENSING UNIT			1						1	1	1	1					
49	12136364	UNIDAD CONDENSADORA	CONDENSING UNIT												1					
49	12343157	UNIDAD CONDENSADORA	CONDENSING UNIT																	1
50	12235243	CONJ. FRONTI POSTIZO CAJ MAGNETI	FRONT DECK SET					1	2	1	2	3	1	2	3	4				
51	12329321	GUIA ACERO LONGITUD 450 (JUEGO)	DRAWER GUIDE					2	4	2	4	6	2	4	6	8				
52	12033405	CAJON 1/3	DRAWER GN 1/3																	
53	12327263	BURLETE CAJON 1/3	DRAWER GASKET GN 1/3																	
54	ANEXO	FRENTE CAJON 1/3	DRAWER FRONT 1/3																	
55	ANEXO	CJ. CAJÓN 1/3	DRAWER SET 1/3																	
56	12032484	CAJON 1/2	DRAWER GN 1/2					2	3	2	4	5	2	4	6	7				
57	12327262	BURLETE CAJON 1/2	DRAWER GASKET 1/2					2	4	2	4	6	2	4	6	8				
58	ANEXO	FRENTE CAJON 1/2	DRAWER FRONT 1/2					2	4	2	4	6	2	4	6	8				
59	ANEXO	CJ. CAJÓN 1/2	DRAWER SET 1/2					2	3	2	4	5	2	4	6	7				
59	ANEXO	CJ. CAJÓN 1/2 LG	DRAWER SET 1/2 L.G.					1			1				1					
46*	12140199	RELE	RELAY	1	1		1	1	1	1	1									X Nov.2023
46*	12058872	RELE	RELAY			1						1	1	1	1	1				X Nov.2023
46*	12058820	COND ARRANQ	COND ARRANQ	1	1		1	1	1	1	1									X Nov.2023
46*	12058824	COND ARRANQ	COND ARRANQ			1						1	1	1	1	1				X Nov.2023

OPCIONALES / OPTINAL

Abrev.	Descripción / Description	ITEM	Reference	Descripción	Description	MESA 2P POSIT	MESA 3P POSIT	MESA 4P POSIT	MESA 2P POSIT HD	MESA 3P POSIT HH	MESA 3P POSIT HDD	MESA 3P POSIT HHD	MESA 3P POSIT HHH	MESA 4P POSIT HDDD	MESA 4P POSIT HHDD	MESA 4P POSIT HHHH	MESA 2P CONG	MESA 3P CONG	RECOMENDADO RECOMMENDEE	ELIMINADO ELIMINATED	INTRODUCIDO INTRODUCED	NOTAS NOTES	
C	RUEDAS / CASTOR	5	12032437	RUEDA S/F Ø80	Ø80 GIRAT WHEEL BRAKE	2	2	3	2	2	2	2	2	3	3	3	2	2					
		6	12034380	RUEDA C/F Ø80	Ø80 GIRAT WHEEL WITH BRAKE	2	2	3	2	2	2	2	2	3	3	3	3	2	2				
		*	ANEXO	TIRADOR PUERTA CRISTAL	GLASS DOOR HANDLE	2	3	4															
GD	PUERTA CRISTAL / GLASS DOOR	*	12046298	PUERTA CRISTAL	GLASS DOOR	2	3	4															
		*	12117149	LED	LED	2	3	4															
		*	12321524	FUENTE ALIMENTACIÓN	POWER SUPPLY	1	1	1															
		23	12037017	SOPORTE BISAGRA INF.	HINGE SUPPORT INF.	2	3	4										2	3				
OP	APERTURA CONTRARIA DE PUERTA / OPPOSITE DOOR	17	12050272	TUERCA TRT M6-2	NUT TRT M6-2	2	3	4										2	3				
		18	12037138	EJE ROSCA EXT.30x10 INOX	SHAFT EXTERNAL THREAD	2	3	4											2	3			
		*	12066753	TAPON	PLUG	3	6	9															
CI	CLAVIJA INGLESA / ENGLISH PLUG	*	12067656	MANGUERA CON CLAVIJA INGLESA 3X1.5	MANGUERA CON CLAVIJA INGLESA 3X1.5	1	1	1	1	1	1	1	1	1	1	1	1	1	1	1	1	1	
AU	CLAVIJA AUSTRALIANA / AUSTRALIAN PLUG	*	12151420	MANGUERA CON CLAVIJA AUSTRALIANA	AUSTRALIAN PLUG	1	1	1	1	1	1	1	1	1	1	1	1	1	1	1	1	1	
AM	CLAVIJA AMERICANA / USA PLUG	*	12030827	MANGUERA CON CLAVIJA AMERICANA	USA PLUG	1	1	1	1	1	1	1	1	1	1	1	1	1	1	1	1	1	
FH	RESISTENCIA MARCO PUERTA / FRAME HEATER	*	12036157	RESIST.MARCO SNACK-2	FRAME RESISTANCE SNACK-2	1	2	3														1	2
		*	12036344	RESIST.MARCO SNACK-1	FRAME RESISTANCE SNACK-1	1	1	1															1

OPCIONALES / OPTINAL

Abrev.	Descripción / Description	ITEM	Reference	Descripción	Description	MESA 2 P POSIT	MESA 3 P POSIT	MESA 4 P POSIT	MESA 2 P POSIT HD	MESA 2 P POSIT HH	MESA 3 P POSIT HDD	MESA 3 P POSIT HDD	MESA 3 P POSIT HHD	MESA 3 P POSIT HHH	MESA 4 P POSIT HDDD	MESA 4 P POSIT HDDD	MESA 4 P POSIT HHHH	MESA 2 P CONG	MESA 3 P CONG	RECOMENDADO RECOMMENDED	ELIMINADO ELIMINATED	INTRODUCIDO INTRODUCED	NOTAS NOTES
						2	3	4															
		22	ANEXO	PUERTA AP.DCHA	AP. RIGHT DOOR	2	3	4										2	3				
		23	12037017	SOPORTE BISAGRA INF.	HINGE SUPPORT INF.	2	3	4										2	3				
		31	12073961	SOP.SUP.PUERTAS 2S GI	UPPER SUPPORT FOR LEFT GROUP DOORS 2S	1			1	1								1					
		31	12073962	SOP.SUP.PUERTAS 3S GI	UPPER SUPPORT FOR LEFT GROUP DOORS 3S		1				1	1	1							1			
		31	12073963	SOP.SUP.PUERTAS 4S GI	UPPER SUPPORT FOR LEFT GROUP DOORS 4S			1							1	1	1	1					
LG	GRUPO IZQUIERDA / LEFT GROUP	41	12239094	UNIDAD EVAPORADORA	EVAPORATOR UNIT	1	1	1	1	1	1	1	1	1	1	1	1						
		41	12239093	UNIDAD EVAPORADORA	EVAPORATOR UNIT													1	1				
		49	12337076	UNIDAD CONDENSADORA	COND. UNIT	1	1		1	1	1	1	1										
		49	12221791	UNIDAD CONDENSADORA	COND. UNIT										1	1	1	1					
		49	12212413	UNIDAD CONDENSADORA	COND. UNIT				1									1	1				
NS	SIN PETO / WITHOUT SPLASH-BACK	7	ANEXO	ENCIMERA-2S SP	TOP-2S NS	1																	
		7	ANEXO	ENCIMERA-3S SP	TOP-3S NS		1																
		7	ANEXO	ENCIMERA-4S SP	TOP-4S NS			1															
		51	12068305	GUIA ACERO LONGITUD 450 (JUEGO)	DRAWER GUIDE																		
		52	12033405	CAJON 1/3	DRAWER 1/3																		
T	CAJÓN 1/3 / DRAWER 1/3	53	12035866	BURLET CAJON 1/3	DRAWER GASKET 1/3																		
		54	ANEXO	FRENTE CAJON 1/3	DRAWER FRONT 1/3																		
		55	ANEXO	CONJUNTO CAJ. 1/3	DRAWER SET 1/3																		

**POSIBLES OPCIONES PARA LAS DISTINTAS POSICIONES**

**ITEM 7 (OPCIONES)**

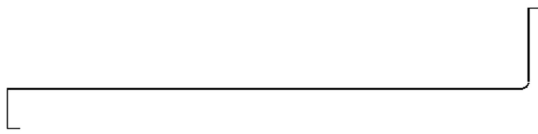

12085882 ENCIMERA MESA 2P\_1  
 12086010 ENCIMERA MESA 2P\_1 SIN PETO -- NS  
 12085884 ENCIMERA MESA 3P\_1  
 12028623 ENCIMERA MESA 3P\_1 SIN PETO -- NS  
 12085886 ENCIMERA MESA 4P\_1  
 12127091 ENCIMERA MESA 4P\_1 SIN PETO -- NS



12038191 ENCIMERA MESA 2P\_2  
 12079636 ENCIMERA MESA 2P\_2 SIN PETO -- NS  
 12038193 ENCIMERA MESA 3P\_2  
 12028623 ENCIMERA MESA 3P\_2 SIN PETO -- NS  
 12026967 ENCIMERA MESA 4P\_2  
 12079638 ENCIMERA MESA 4P\_2 SIN PETO -- NS

ITEM_22	12122206 PUERTA TIRADOR_1 --> APERTURA IZQ 12128719 PUERTA TIRADOR_1 --> APERTURA DCH	12079604 PUERTA TIRADOR_2 --> APERTURA IZQ 12085166 PUERTA TIRADOR_2 --> APERTURA DCH	12085185 PUERTA TIRADOR_3 --> APERTURA IZQ 12294603 PUERTA TIRADOR_3 --> APERTURA DCH
ITEM_54	12343328 FRENTE CAJÓN 1/3_1	12085249 FRENTE CAJÓN 1/3_2	FRENTE CAJÓN 1/3_3
ITEM_55	12343329 CJ. CAJÓN 1/3_1	12085251 CJ. CAJÓN 1/3_2	CJ. CAJÓN 1/3_3
ITEM_58	12131391 FRENTE CAJÓN 1/2_1	12079621 FRENTE CAJÓN 1/2_2	12085293 FRENTE CAJÓN 1/2_3
ITEM_59	12131390 CJ. CAJÓN 1/2_1 12131393 CJ. CAJÓN 1/2_1 LADO GRUPO	12079612 CJ. CAJÓN 1/2_2 12079613 CJ. CAJÓN 1/2_2 LADO GRUPO	12085294 CJ. CAJÓN 1/2_3 12085295 CJ. CAJÓN 1/2_3 LAGO GRUPO

**ITEM 28 (OPCIONES)**

12047691 TERMOSTATO REFRIGERACIÓN  
 12049777 TERMOSTATO CONGELACIÓN



12213060 TERMOSTATO REFRIGERACIÓN  
 12213064 TERMOSTATO CONGELACIÓN



**INTERRUPTOR BIPOLAR (OPCIONES)**

12037293 INT. BIPOLAR\_LUMINOSO AMBAR

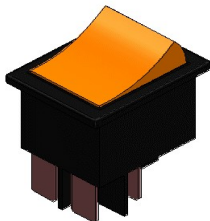

12049461 INT. BIPOLAR NEGRO

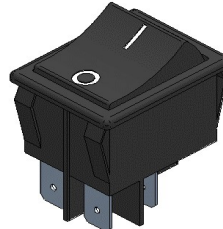



**INTERRUPTOR UNIPOLAR (OPCIONES)**

12037353 INT. UNIPOLAR\_LUMINOSO AMBAR

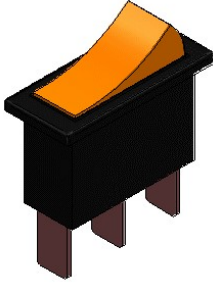

12058759 INT. UNIPOLAR NEGRO

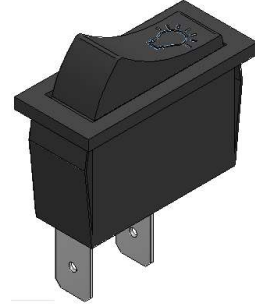

**TIRADOR PUERTA DE CRISTAL**

12068289 TIRADOR\_1

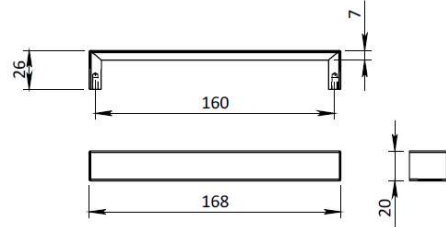
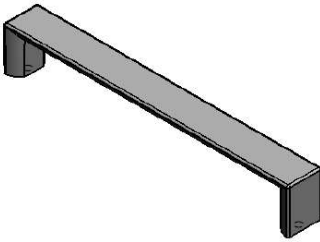

12068291 TIRADOR\_2

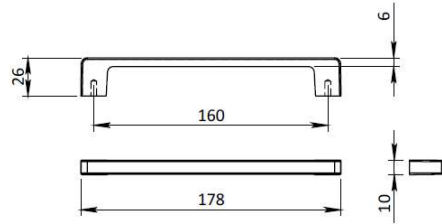
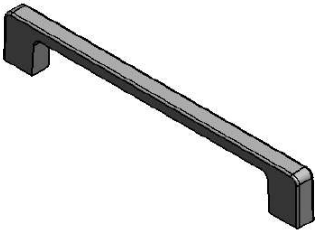

12068290 TIRADOR\_3

